

## STEP 1: MOUNTING THE HEATER Mounting

1. Secure the mounting bracket to the wall.
2. Lower the water heater onto the bracket plate. Bracket can slide from left to right for alignment.
3. Secure the lower and upper bracket to the wall to fix in place.

 The back of the carton can be used as a template for placement.

## STEP 2: WATER CONNECTION Water Quality & Supply

1. Connect cold and hot water at designated inlets.
2. Install a 150 psi rated pressure relief valve at hot water outlet connections.
3. Water pressure of 65 psi (448 kPa) is required to achieve maximum flow rate.

 Use service valves for future service of the water heater. Expansion Tank required for installations using Recirculation.

## STEP 3: GAS CONNECTION Gas Supply

1. Ensure that all gas connections, regulator(s), and meter are sized properly for the BTU/h rating. This unit is 1/2" gas line compatible (refer to Use & Care for requirements and check local codes).
2. Install the gas shut-off valve directly on the gas supply connection on the bottom of the water heater.
3. Connect the gas piping to the gas inlet connector.
4. Check all connections and fittings for leaks.

 A properly sized and installed gas supply is critical to the proper operation of this water heater. Please see National and Local Fuel Gas Code for details.

## CONDENSATION LINE Condensate

External Condensation Neutralizer should be installed in accordance with local codes. Pipe condensation drain line to suitable drain or to the outdoors.

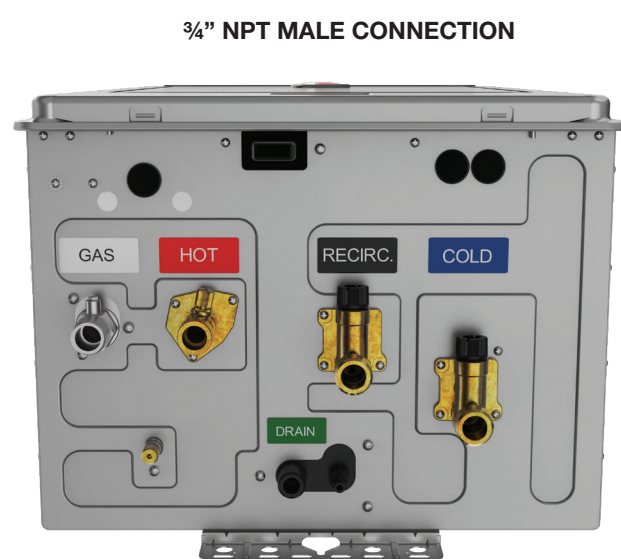
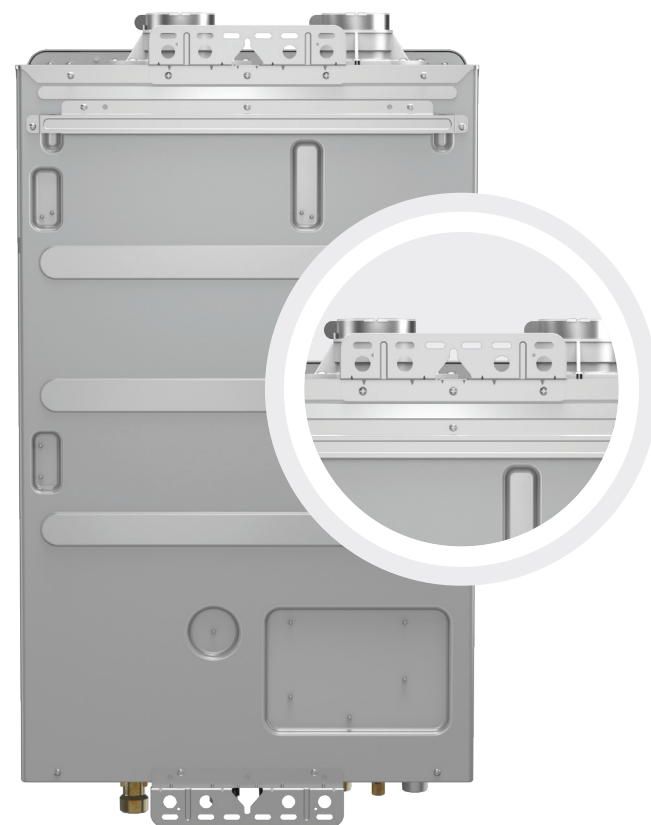

## STEP 5: ELECTRICAL Electrical Wiring

1. This water heater plugs into a standard 120VAC, 3-prong grounded outlet for indoor installation. Hard wiring is required for outdoor installation. Refer to "Outdoor Conversion Instructions" for outdoor installation.
2. DO NOT connect this water heater to a GCFI or AFCI circuit. When there is no code, reference national electric code.

 This water heater only draws a maximum of 3 amps of current. (120V/60Hz at 2 amps)

## START UP Start Up

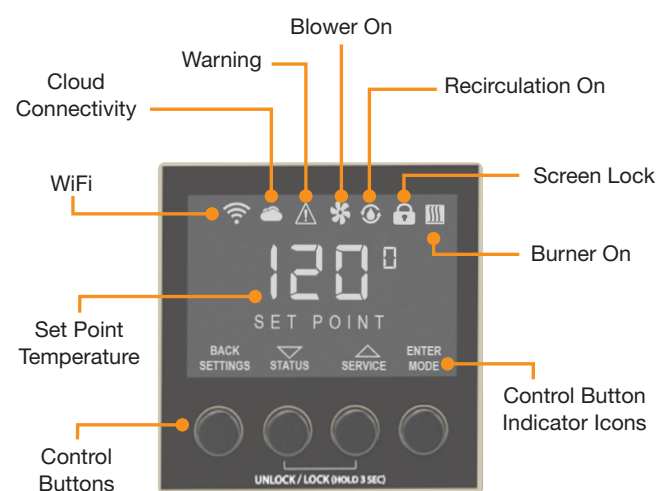

### ENABLE (POWER ON)

Press the "MODE" button. After the LCD displays ENABLE/DISABLE, press the "▲" or "▼" button until "ENABLE" is displayed, and press "ENTER" button.

### DISABLE (POWER OFF)

Press the "▲" or "▼" button until "DISABLE" is displayed, and press "ENTER" button.

### SETTING THE TEMPERATURE

1. Press the "SETTINGS" button to access the settings menu.
2. Scroll thru the menu to select "SET POINT" mode. Press "ENTER" button.
3. Press the "▲" or "▼" button to desired set temperature and press the "ENTER" button.

### HIGH ALTITUDE ADJUSTMENTS

Section	High-Altitude
Sea Level	0-2,000 ft. (0 m - 610 m)
Low Altitude	2,001 ft. - 5,400 ft. (610 m - 1,650 m)
Med. Altitude	5,400 ft. - 7,900 ft. (1,650 m - 2,410 m)
High Altitude	7,901 ft. - 10,200 ft. (2,410 m - 3,110 m)

1. Press the "SETTINGS" button to access the settings menu.
2. Turn off the gas and water to the water heater by closing the shut-off valves.
3. Press the "▲" or "▼" button until "Tankless Config" is displayed, and press the "ENTER" button.
4. Press the "▲" or "▼" button until "Elevation" is displayed, and press the "ENTER" button.
5. The Factory setting is "Sea Level". Press the "▲" or "▼" button to choose "Low Altitude", "Med. Altitude" or "High Altitude", and press the "ENTER" button to confirm. To exit this setting, press the "Back" button until the initial screen is displayed.
6. Turn on the gas and water to the water heater by opening the shut off valves.

## STEP 4: VENTING Venting

**DIRECT VENT INSTALLATION**  
Compatible with Schedule 40 PVC, CPVC, and ABS venting (2" or 3"). Also compatible with Centrotherm InnoFlue® venting.

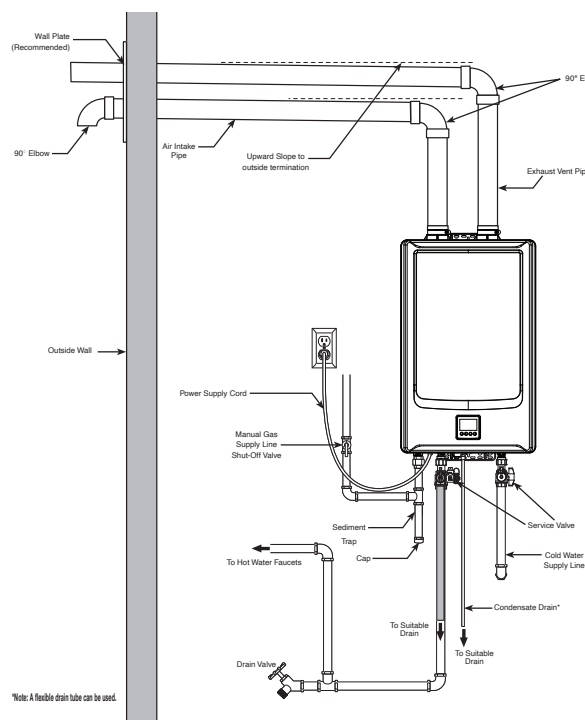

**ROOM AIR INTAKE COMPATIBLE**  
(Only IF conditions met per Use & Care Manual)  
A 90 degree elbow must be installed at the air intake termination.

### FLEX VENTING COMPATIBLE

Centrotherm InnoFlue® 2" flex vent is allowed up to 50 ft. Handles up to 45 degree offsets. Requires a proper adaptor - Part # SP21091 (in vertical applications only).

 This water heater may use indoor air for combustion, but combustion air requirements must be met.

 Please see Use & Care section "Installation for Power Vent (Air Room Application)" for details.

### CONCENTRIC VENT TERMINATION

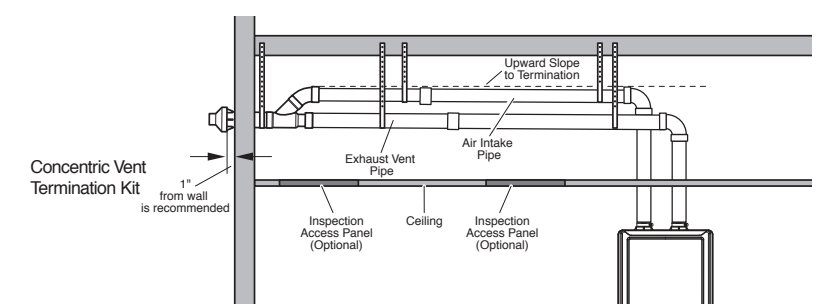

### FLAT VENT TERMINATION

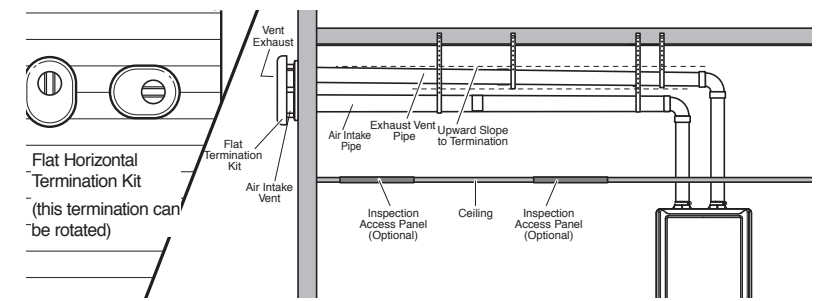

 It is recommended that the air intake pipe and exhaust pipe have a 1/4" per foot upward slope toward the outdoors. A condensation collar may be needed to prevent intake vent condensation from entering the water heater.  
When not using a termination kit, keep at least a 12 inch gap between exhaust and air intake terminations to ensure clean air.

### COMMON VENTING

Up to 2 heaters with 3" common vent up to 60 ft. Additional components required (see Use & Care Manual).

SINGLE UNIT: MAX. EQUIVALENT VENT LENGTHS - STRAIGHT PIPE			EQUIVALENT FT. OF ELBOWS	
Number of 90° Elbows	Max Length 2" Straight Pipe	Max Length 3" Straight Pipe	2" Pipe	3" Pipe
0	70 ft. (21.3 m)	150 ft. (45.7 m)	90° 6 ft. (1.83 m)	5 ft. (1.52 m)
1	64 ft. (19.5 m)	145 ft. (44.2 m)	45° 3 ft. (0.9 m)	2.5 ft. (0.75 m)
2	58 ft. (17.7 m)	140 ft. (42.7 m)		
3	52 ft. (15.8 m)	135 ft. (41.1 m)		
4	46 ft. (14.0 m)	130 ft. (39.6 m)		
5	40 ft. (12.2 m)	125 ft. (38.1 m)		
6	34 ft. (10.4 m)	120 ft. (36.6 m)		

## RECIRCULATION - SR MODELS WITH BUILT-IN RECIRCULATION ONLY Recirculation

### CROSSOVER VALVE SHOULD BE AT THE FARTHEST FIXTURE

Install a properly sized thermal expansion tank downstream of the check valve.

- Crossover Flow Rate: approximately 1.0 gpm

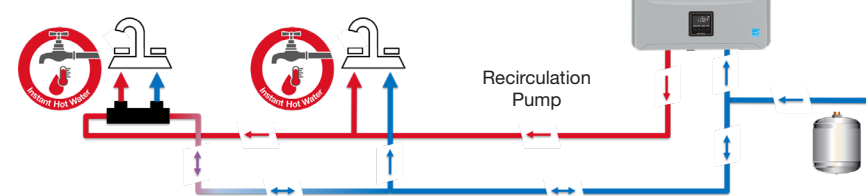

### CROSSOVER VALVE INSTALLATION EXAMPLE:



### DEDICATED RECIRCULATION LINE IS RECOMMENDED

- Return line should be connected at "Return" connection on water heater.
- The expansion tank should be installed in either the hot water line or the recirculation line.

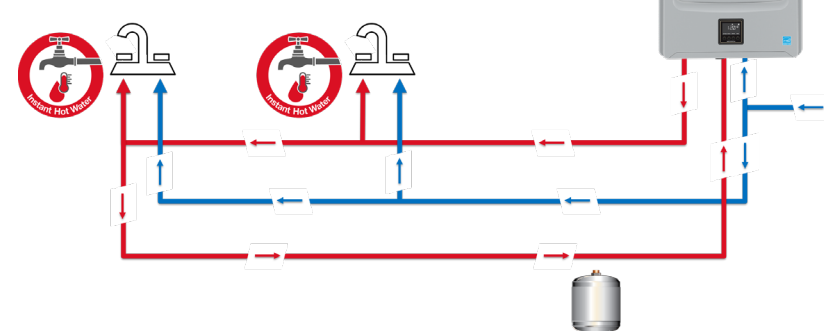

### SETTING UP RECIRCULATION

1. Press the "SETTINGS" button.
2. Press the "▲" or "▼" button until "Tankless Config" is displayed then press the "ENTER" button.
3. Press the "▲" or "▼" button until "Recirc. Pump Modes" is displayed then press the "ENTER" button.

Pump Mode Name	Timer Based		On-Demand	Schedule Based
	Timer Perf (Performance Mode)	Timer E-Saver (Energy Saver Mode)	On-Demand	Schedule (In EcoNet® App ONLY)
Pump Mode Description	Pump cycles ON Every 15 to 30 minutes	Pump cycles ON Every 30 to 60 minutes	Can be activated using wired push button (SP20863), motion sensor kit (SP20862), or directly from the unit by setting the "Recirc. Pump" to ON, through the EcoNet® app.	Set specific times of the day/week for the "Recirc. Pump" to turn on (Performance Mode during selected timeframes).
Benefit	Best option for instant hot water availability	Better energy savings, however, may result in an increased likelihood of lukewarm water between pump cycles.	Ensures hot water availability at time of use.	Optimized option between Performance Mode and energy savings during off-peak hours. Recirculation pump is not activated outside of scheduled time.

 No matter which recirculation pump mode setting, the pump can always be activated for on demand hot water from the EcoNet® app.

 Scan QR Code to download the EcoNet® App.





**TROUBLESHOOTING**

If a problem occurs, the unit will stop operating and display an error code. The most common error codes on start-up are:

Error Code	Possible Cause	Solution
A011	Failed to Ignite	Check the gas and purge any air from lines
A012	Lost Flame	Check the gas supply, maybe insufficient
T113	Not enough water flow	Try another fixture or faucet
A090	Blockage in venting detected	Ensure correct vent installation with no blockages and vent connections



Press and hold "STATUS" button to quickly view GPM, inlet temperature, and outlet temperature.



Use QR code located on the back cover for additional troubleshooting resources.

**CLEARING ALARMS**

Now Press the "▲" or "▼" button to increase or decrease the temperature (1°F Increments).

1. Press the "SERVICE" button and press the "ENTER" button.
2. Press the "▲" or "▼" button until "Current Alarms" is displayed then press the "ENTER" button.
3. Press the "▲" or "▼" button until "Clear Alarms?" is displayed then press the "ENTER" button.
4. Press the "▲" or "▼" button until "Yes" is displayed then press the "ENTER" button.

**BEFORE YOU BEGIN**

This guide is designed to provide a high-level installation overview and address key installation questions. It is not intended to replace the "Installation Instructions" in the Use and Care Manual provided with the water heater. All instructions and installation requirements as well as any local or national codes, must be followed.

It is recommended that this product be installed and serviced by a licensed plumber or a professional service technician. Rheem is not liable for any damages or defects resulting from improper installation.



This icon will tell you which section of the use & care manual to check for more information.



This icon will point out helpful Installation tips.



This icon will point out information that is key to a safe installation.

**A SUCCESSFUL INSTALL STARTS HERE**

**INSPECT SHIPMENT**

- Check product for damage
- Ensure all pieces in box



Inspect Product

**FIND INSTALL LOCATION**

Consider The Following:

- Sturdy Wall
- Gas, Water, and Power supply
- Venting Termination
- Condensate Neutralizer and Drain
- Enough space - see below for minimum clearance required (all models)

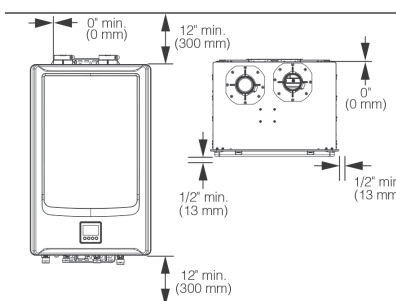

Choosing a Location

**GATHER KEY ACCESSORIES**



Gas Shutoff Valve Part # RTG20074EH

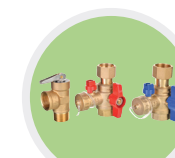

Isolation Valves Part # RTG20326



Horizontal Term. Kit Part # 2" -SP21069G, 3" - SP21069E



Vertical Term. Kit Part # 2" -SP202897, 3" - SP20245



Condensate Neutralizer Part # SP12151 or RXGY-A01



Expansion Tank



Crossover Valve Part # RTG20285

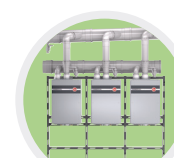

EZ Rack Kit Part # RTG20304

**Outdoor Conversion Kit (RTGH-SX)**

This water heater can be converted from indoor model to outdoor model if following "Outdoor Conversion Instructions"



OPEN TO VIEW INSTALL GUIDE

**CUSTOMER SERVICE/NEED HELP**

HAVE QUESTIONS? NEED HELP TROUBLESHOOTING?

Get the unit's Model and Serial Numbers ready and contact us: **US** 1.800.432.8373 / **Canada** 1.800.268.6966

Be sure to have your **Model and Serial Numbers** before calling customer service (located on the water heater's Rating Label)

**TIPS & MAINTENANCE**



**DRAINING THE WATER HEATER**

WARNING: IF THE BUILDING IS TO REMAIN UNOCCUPIED FOR AN EXTENDED PERIOD, IT IS RECOMMENDED THAT THE TANKLESS WATER HEATER BE DRAINED TO PREVENT POSSIBLE DAMAGE DUE TO FREEZING CONDITIONS.



Draining the Water Heater

**FLUSHING THE UNIT**

To ensure the best continued performance from your tankless water heater, we recommend cleaning your unit every year to year and a half. This process is called "flushing." Please refer to proper flushing procedures which can be found utilizing the QR code below.

To make this servicing even easier for you to remember, we've added a Maintenance Notification Setting to remind you that it is time to flush via a flashing code "T111" on your tankless display or through the Econet® App on your phone (Wi-Fi Models Only).

**SETTING SERVICE ALERT HOURS**

1. Press the "SERVICE" button.
2. Press the "▲" or "▼" button until "Service Alert" is displayed then press the "ENTER" button.
3. Press the "▲" or "▼" button until "500 Hours, 750 Hours or 1000 Hours" is displayed then press the "ENTER" button.

HOURS TO MAINTENANCE NOTIFICATION  
(Programmed by Installer during Installation)



Scan for additional information regarding install, servicing, and warranty registration.

**IF YOU HAVE A PROBLEM OR ISSUE WITH THIS WATER HEATER DO NOT RETURN, CALL FIRST.**

Manufacturer National Service Department  
1-866-720-2076

(AP 19637)

**TANKLESS EASY INSTALLATION GUIDE**

Tips for Professional Installation & Product Setup



**REGISTER YOUR 15 YEAR WARRANTY\***

To register your product, scan the QR code located on the back cover. You will need your unit model and serial numbers to complete this process. These can be found on the label on the top panel inside of the tankless water heater.

\*All warranties void after 12,000 hours of operation. Warranty is provided to original customer after online product registration under residential installation.

NOTE: For Warranty Type, select "Standard" for all tankless products. The owner is required to provide proof of purchase/ownership at the time of the claim.

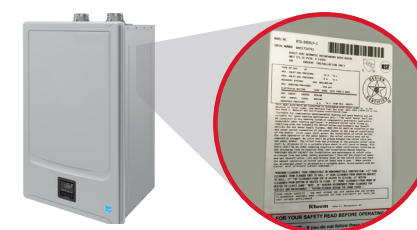

**PRODUCT INFORMATION**

MODEL: \_\_\_\_\_  
SERIAL #: \_\_\_\_\_  
INSTALL DATE: \_\_\_\_\_

**INSTALLER INFORMATION**

NAME: \_\_\_\_\_  
COMPANY: \_\_\_\_\_  
PHONE: \_\_\_\_\_